



Features

- Out-of-the-Box Installation and Commissioning
- Ultrasonic Airflow Sensing
- Laser-Based Absolute Smoke Detection
- Pre-engineered pipe network designs
- Programmable Alarm Thresholds
- Clean air barrier optics protection
- Instant Recognition Display
- Instant Fault Finder™
- AutoLearn™ Smoke
- AutoLearn™ Flow
- Field Service Access Door
- Multiple Event Logging in separate logs
- Event log – up to 18000 events
- Offline/online configuration capability
- Up to 250 m² (2,690 sq. ft.) coverage*

Listings/Approvals

- UL
- ULC
- CCC
- FM
- ActivFire
- CE
- LPCB
- VdS
- VNIPO
- NF
- EN 54-20
 - Class A (12 holes / 0.12% obs/m)
 - Class B (12 holes / 0.35% obs/m)
 - Class C (12 holes / 0.80% obs/m)

Classification of any configuration is determined using ASPIRE.

Regional approvals listings and regulatory compliance vary between VESDA product models. Refer to www.xtralis.com for the latest product approvals matrix.

The VESDA VLF-250 detector is a very early warning smoke detector designed to protect small, business-critical environments of less than 250 m² (2,690 sq. ft.).

The detector works by continually drawing air into sampling holes in a pipe network. The air is filtered and passed into a detection chamber where light scattering technology detects the presence of very small amounts of smoke. Detector status information is communicated on the detector display and via relays or optional interface cards.

Out-of-the-box operation

The VLF can be installed and commissioned out-of-the-box without the need for a special interface or software programming tools.

In operation, the unique Smoke Dial™ display provides the user with an instant understanding of a smoke event, even from a distance. Should a fault occur, the user simply opens the field service door and activates the Instant Fault Finder feature to determine the specific fault condition. This information can then be passed onto their fire service company, ensuring that service technicians arrive onsite fully prepared.

Ultrasonic Flow Sensing

The patent-pending Ultrasonic Flow Sensing used in the VLF provides a direct reading of the sampling pipe flow rate. The system is immune to air temperature and pressure changes and is unaffected by contamination. The VLF is the first air sampling smoke detector to use ultrasonic flow sensing.

VESDA VLF

VLF-250

Specifications

Input Power

Voltage: 24V DC Nominal (18-30 V DC)
 Current @ 24 VDC: 220 mA nominal, 295 mA in alarm

Dimensions (W x H x D)

256 mm x 183 mm x 92 mm (10¹/₁₆ in x 7¹/₅ in x 3²/₃ in)

Weight

Approx. 2 kg (4.4 lbs)

IP Rating

IP30

Mounting

Upright, inverted or horizontal

Operating Conditions*

Ambient: 0°C to 39°C (32°F to 103°F)*
 Tested to (EN54-20): -10°C to 55°C (14°F to 131°F)
 Sampled Air**: -20°C to 60°C (-4°F to 140°F)
 Humidity: 5% to 95% RH, non-condensing

Sampling Network

Maximum pipe lengths: 1 x 25 m (80 ft) (Max. 12 holes)
 2 x 15 m (50 ft) per branch (Max. 6 holes per branch)
 Sampling Hole Options: Pre-Engineered Option or Maximum Pipe length in accordance with Pipe Modelling Design Tool (ASPIRE™)

Air Inlet Pipe

Accepts both metric and American standard pipe sizes
 Metric: 25 mm (1.05 in.) American Pipe: IPS 21 mm (¾ in.)

Area Coverage

Up to 250 m² (2,690 sq. ft.) depending on local codes and standards

Relay Outputs

3 changeover relays (Fire 1, Action, Fault), Contacts rated 2A @ 30 VDC (max). NO/NC Contacts

Cable Access

3 x 25 mm (1.05 in.) cable entries (1 rear entry, 2 top entry)

Cable Termination

Screw Terminals 0.2-2.5 mm² (30-12 AWG)

Interfaces

Shown in Terminal Block Connections diagram, to right, plus an RS232 Programming Port.
 General Purpose Input (GPI) interface offers: Reset, Disable, Standby, Alarm set 1, Alarm set 2 and External Input functions.

Alarm Threshold Setting Range

Alert, Action 0.025 - 2.00% obs/m (0.008 - 0.625% obs/ft)
 Fire 1, Fire 2 0.025 - 20.00% obs/m (0.008 - 6.25% obs/ft)
 Individual Alarm Delays 0 - 60 seconds
 Two Alarm Threshold Settings Either time or GPI based

Display

- 4 Alarm State Indicators
- Smoke Level Indicator
- Reset, Disable and Test Controls
- Fault and Disabled Indicators
- Instant Fault Finder
- Smoke and Flow AutoLearn Controls

Event Log

Up to 18000 events, time and date stamped in separate, non-volatile, logs for: Smoke Level, Flow Level, Detector Status and Faults

AutoLearn Smoke & Flow

- Automatically set acceptable alarm thresholds for both smoke and flow levels
- Minimum 15 minutes, maximum 15 days (default 14 days)
- During AutoLearn thresholds are NOT changed from pre-set values

Warranty Period

2 years

Ordering Information:

VLF-250-00 VESDA VLF. European language set. English display labels
 VLF-250-01 VESDA VLF. European language set. International display labels
 VLF-250-02 VESDA VLF. English + Asian language set. International display labels
 VLF-250-04 VESDA VLF. English + Russian language set. International display labels
 VLF-250-05 VESDA VLF. English + Eastern Euro language set. International display labels
 VIC-010 VESDAnet Interface Card, VIC-020 Multifunction Control Card (MCC)
 VIC-030 Multifunction Control Card (MCC) with Monitored Powered Output (MPO)
 VSP-005 Filter Cartridge
 VSP-722 Aspirator for VESDA VLF-250

Display:

The display provided to the user includes a Smoke Dial™ and alarm and status indicators.

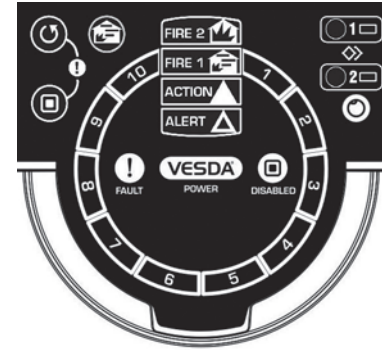

When the field service access door is open, the user has access to the RESET, DISABLE, Fire Test, AutoLearn and Instant Fault Finder functions. When the Instant Fault Finder function is activated, the Smoke Dial™ converts to a fault indicator, with the dial segment numbers corresponding to the faults listed below.

Legend of fault indicators:

- | | |
|-------------|-----------------------|
| 1 Filter | 6 External Device/PSU |
| 2 Aspirator | 7 Interface card |
| 3 High flow | 8 Field wiring |
| 4 Low flow | 9 AutoLearn Fail |
| 5 n/a | 10 Detector failure |

Terminal Block Connections:

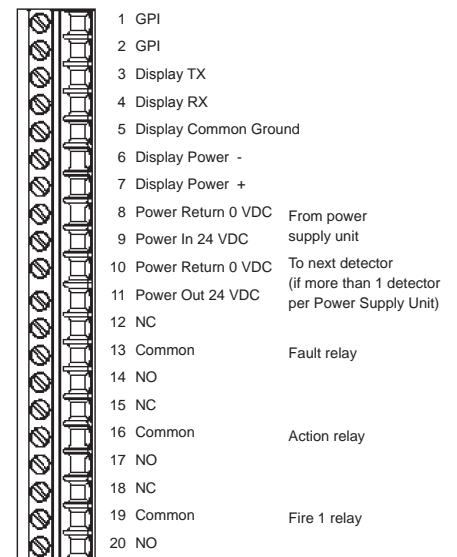

Approvals Compliance

Please refer to the Product Guide for details regarding compliant design, installation and commissioning.

* Product UL listed for use from 0°C to 38°C (32°F to 100°F).

** Sampled Air temperature shall reach Ambient Detector temperature upon entry into Detector. Refer to Xtralis Design Guides & Application Notes for sampled air pre-conditioning.

www.xtralis.com

UK and Europe +44 1442 242 330 D-A-CH +49 431 23284 1 The Americas +1 781 740 2223

Middle East +962 6 588 5622 Asia +86 21 5240 0077 Australia and New Zealand +61 3 9936 7000

The contents of this document are provided on an "as is" basis. No representation or warranty (either express or implied) is made as to the completeness, accuracy or reliability of the contents of this document. The manufacturer reserves the right to change designs or specifications without obligation and without further notice. Except as otherwise provided, all warranties, express or implied, including without limitation any implied warranties of merchantability and fitness for a particular purpose are expressly excluded.

Xtralis, the Xtralis logo, The Sooner You Know, VESDA-E, VESDA, ICAM, ECO, OSID, HeiTel, ADPRO, IntrusionTrace, LoiterTrace, ClientTrace, SmokeTrace, XQa, XOh, iTrace, iCommand, iRespond, iCommission, iPIR, and FMST are trademarks and/or registered trademarks of Xtralis and/or its subsidiaries in the United States and/or other countries. Other brand names mentioned herein are for identification purposes only and may be trademarks of their respective holder(s). Your use of this document does not constitute or create a licence or any other right to use the name and/or trademark and/or label.

This document is subject to copyright owned by Xtralis. You agree not to copy, communicate to the public, adapt, distribute, transfer, sell, modify or publish any contents of this document without the express prior written consent of Xtralis.





Features

- Out-of-the-Box Installation and Commissioning
- Ultrasonic Airflow Sensing
- Laser-Based Absolute Smoke Detection
- Pre-engineered pipe network designs
- Programmable Alarm Thresholds
- Clean air barrier optics protection
- Instant Recognition Display
- Instant Fault Finder™
- AutoLearn™ Smoke
- AutoLearn™ Flow
- Field Service Access Door
- Multiple Event Logging in separate logs
- Event log – up to 18000 events
- Offline/online configuration capability
- Up to 500 m² (5,380 sq. ft.) coverage*

The VESDA VLF-500 detector is a very early warning smoke detector designed to protect small, business-critical environments of less than 500 m² (5,380 sq. ft.)

The detector works by continually drawing air into sampling holes in a pipe network. The air is filtered and passed into a detection chamber where light scattering technology detects the presence of very small amounts of smoke. Detector status information is communicated on the detector display and via relays or optional interface cards.

Out-of-the-box operation

The VLF can be installed and commissioned out-of-the-box without the need for a special interface or software programming tools.

In operation, the unique Smoke Dial™ display provides the user with an instant understanding of a smoke event, even from a distance. Should a fault occur, the user simply opens the field service door and activates the Instant Fault Finder feature to determine the specific fault condition. This information can then be passed onto their fire service company, ensuring that service technicians arrive onsite fully prepared.

Ultrasonic Flow Sensing

The patent-pending Ultrasonic Flow Sensing used in the VLF provides a direct reading of the sampling pipe flow rate. The system is immune to air temperature and pressure changes and is unaffected by contamination. The VLF is the first air sampling smoke detector to use ultrasonic flow sensing.

Listings/Approvals

- UL
- ULC
- CCC
- FM
- ActivFire
- CE
- LPCB
- VdS
- VNIPO
- NF
- EN 54-20
 - Class A (30 holes / 0.05% obs/m)
 - Class B (30 holes / 0.15% obs/m)
 - Class C (30 holes / 0.32% obs/m)

Classification of any configuration is determined using ASPIRE.

Regional approvals listings and regulatory compliance vary between VESDA product models. Refer to www.xtralis.com for the latest product approvals matrix.

VESDA VLF

VLF-500

Specifications

Input Power

Voltage: 24V DC Nominal (18-30 V DC)
 Current @ 24 VDC: 410 mA nominal, 490 mA in alarm

Dimensions (W x H x D)

256 mm x 183 mm x 92 mm (10¹/₁₆ in x 7¹/₅ in x 3²/₃ in)

Weight: Approx. 2 kg (4.4 lbs)

IP Rating: IP30

Mounting: Upright, inverted or horizontal

Operating Conditions*

Ambient: 0°C to 39°C (32°F to 103°F)*
 Tested to (EN54-20): -10°C to 55°C (14°F to 131°F)
 Sampled Air**: -20°C to 60°C (-4°F to 140°F)
 Humidity: 5% to 95% RH, non-condensing

Sampling Network

Maximum pipe lengths: 1 x 50 m (150 ft) (Max. 24 holes)
 2 x 30 m (90 ft) per branch (Max. 12 holes per branch)
 Sampling Hole Options: Pre-Engineered Option or Maximum Pipe length in accordance with Pipe Modelling Design Tool (ASPIRE™)

Air Inlet Pipe

Accepts both metric and American standard pipe sizes
 Metric: 25 mm (1.05 in.) American Pipe: IPS 21 mm (¾ in.)

Area Coverage

Up to 500 m² (5,380 sq. ft.) depending on local codes and standards

Relay Outputs

3 changeover relays (Fire 1, Action, Fault), Contacts rated 2A @ 30 VDC (max). NO/NC Contacts

Cable Access

3 x 25 mm (1¹/₁₆ in.) cable entries (1 rear entry, 2 top entry)

Cable Termination

Screw Terminals 0.2-2.5 mm² (30-12 AWG)

Interfaces

Shown in Terminal Block Connections diagram, to right, plus an RS232 Programming Port.
 General Purpose Input (GPI) interface offers: Reset, Disable, Standby, Alarm set 1, Alarm set 2 and External Input functions.

Alarm Threshold Setting Range

Alert, Action 0.025 - 2.00% obs/m (0.008 - 0.625% obs/ft)
 Fire 1, Fire 2 0.025 - 20.00% obs/m (0.008 - 6.25% obs/ft)
 Individual Alarm Delays 0 - 60 seconds
 Two Alarm Threshold Settings Either time or GPI based

Display

- 4 Alarm State Indicators
- Smoke Level Indicator
- Reset, Disable and Test Controls
- Fault and Disabled Indicators
- Instant Fault Finder
- Smoke and Flow AutoLearn Controls

Event Log

Up to 18000 events, time and date stamped in separate, non-volatile, logs for: Smoke Level, Flow Level, Detector Status and Faults

AutoLearn Smoke & Flow

- Automatically set acceptable alarm thresholds for both smoke and flow levels
- Minimum 15 minutes, maximum 15 days (default 14 days)
- During AutoLearn, thresholds are NOT changed from pre-set values

Warranty Period

2 years





Ordering Information:

VLF-500-00 VESDA VLF. European language set. English display labels
 VLF-500-01 VESDA VLF. European language set. International display labels
 VLF-500-02 VESDA VLF. English + Asian language set. International display labels
 VLF-500-04 VESDA VLF. English + Russian language set. International display labels
 VLF-500-05 VESDA VLF. English + Eastern Euro language set. International display labels
 VIC-010 VESDAnet Interface Card
 VIC-020 Multifunction Control Card (MCC)
 VIC-030 Multifunction Control Card (MCC) with Monitored Powered Output (MPO)
 VSP-005 Filter Cartridge
 VSP-715 Aspirator for VESDA VLF-500

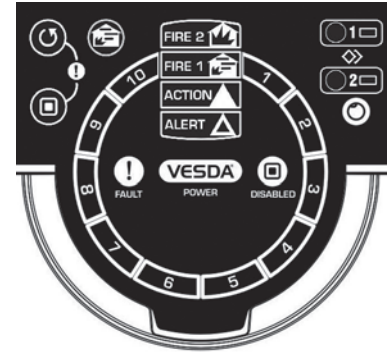
Display

The display provided to the user includes a Smoke Dial™ and alarm and status indicators.



When the field service access door is open, the user has access to the RESET , DISABLE , Fire Test , AutoLearn  and Instant Fault Finder functions. When the Instant Fault Finder function is activated, the Smoke Dial™ converts to a fault indicator, with the dial segment numbers corresponding to the faults listed below.

Legend of fault indicators

- | | |
|-------------|-----------------------|
| 1 Filter | 6 External Device/PSU |
| 2 Aspirator | 7 Interface card |
| 3 High flow | 8 Field wiring |
| 4 Low flow | 9 AutoLearn Fail |
| 5 n/a | 10 Detector failure |

Terminal Block Connections

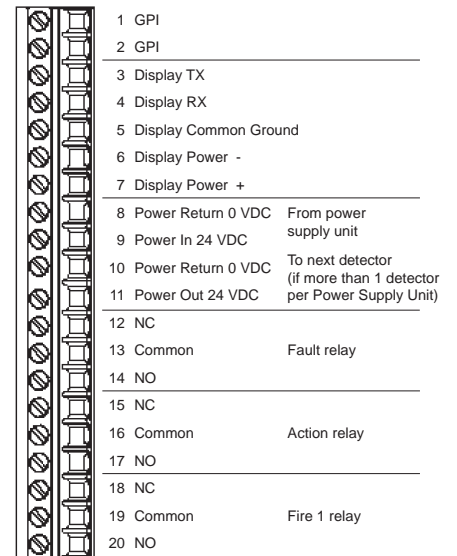

Approvals Compliance

Please refer to the Product Guide for details regarding compliant design, installation and commissioning.

* Product UL listed for use from 0°C to 38°C (32°F to 100°F).

** Sampled Air temperature shall reach Ambient Detector temperature upon entry into Detector. Refer to Xtralis Design Guides & Application Notes for sampled air pre-conditioning.

www.xtralis.com

UK and Europe +44 1442 242 330 D-A-CH +49 431 23284 1 The Americas +1 781 740 2223

Middle East +962 6 588 5622 Asia +86 21 5240 0077 Australia and New Zealand +61 3 9936 7000

The contents of this document are provided on an "as is" basis. No representation or warranty (either express or implied) is made as to the completeness, accuracy or reliability of the contents of this document. The manufacturer reserves the right to change designs or specifications without obligation and without further notice. Except as otherwise provided, all warranties, express or implied, including without limitation any implied warranties of merchantability and fitness for a particular purpose are expressly excluded.

Xtralis, the Xtralis logo, The Sooner You Know, VESDA-E, VESDA, ICAM, ECO, OSID, HeiTel, ADPRO, IntrusionTrace, LoiterTrace, ClientTrace, SmokeTrace, XQa, XOh, iTrace, iCommand, iRespond, iCommission, iPIR, and FMST are trademarks and/or registered trademarks of Xtralis and/or its subsidiaries in the United States and/or other countries. Other brand names mentioned herein are for identification purposes only and may be trademarks of their respective holder(s). Your use of this document does not constitute or create a licence or any other right to use the name and/or trademark and/or label.

This document is subject to copyright owned by Xtralis. You agree not to copy, communicate to the public, adapt, distribute, transfer, sell, modify or publish any contents of this document without the express prior written consent of Xtralis.

